

4/2 Magnetwegeventile NG6 / CTOP3

- max. Betriebsdruck 315 bar
- max. Rücklaufdruck Tank 160 bar
- max. Durchfluss 45 l/min.

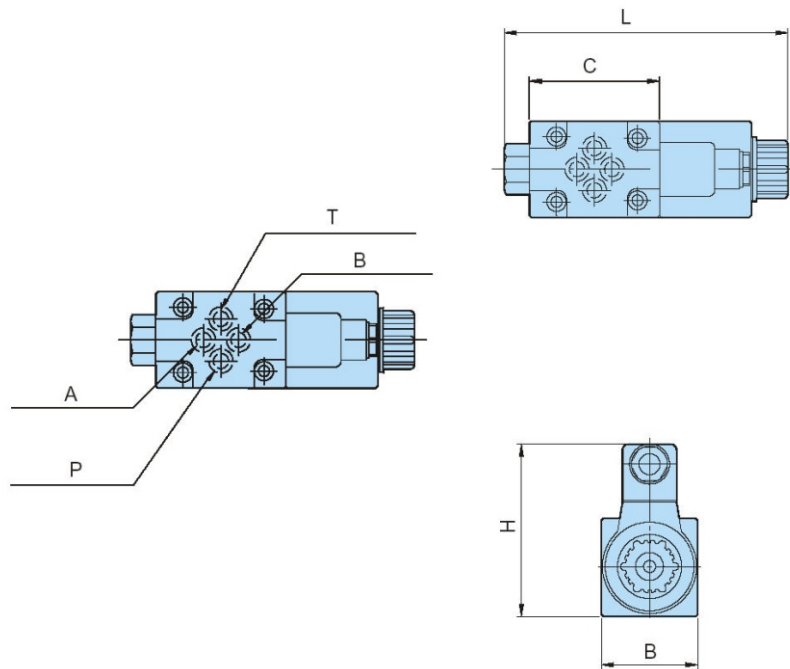

Artikel	Bezeichnung	Symbol	L	B	H	C
210805	DSG 2B2-N-01-DC12		215	48	86	65
210806	DSG 2B2-N-01-DC24		215	48	86	65
210807	DSG 2B2-N-01-AC220		193	48	86	65
210815	DSG 2B3-N-01-DC12		215	48	86	65
210816	DSG 2B3-N-01-DC24		215	48	86	65
210817	DSG 2B3-N-01-AC220		193	48	86	65
210825	DSG 2B3B-N-01-DC12		215	48	86	65
210826	DSG 2B3B-N-01-DC24		215	48	86	65
210827	DSG 2B3B-N-01-AC220		215	48	86	65